

LED PANEL G3 LED FLAT PANEL FIXTURE | FLEXWATT + FLEXCOLOR + FLEXCONTROL



2x2, 2x4 & 1x4 flexibility

THE LED PANEL G3 IS OUR LATEST GENERATION OF EDGE-LIT LED FLAT PANEL FIXTURES, WHICH INTEGRATES REMPHOS' FLEXCOLOR, FLEXWATT & FLEXCONTROL TECHNOLOGIES.

selectable wattage & color temperature

flexCOLOR

- 3500°K NEUTRAL WHITE
- 4000°K NEUTRAL WHITE
- 5000°K COOL WHITE

flexWATT

2x2	16W	20W	24W	28W
1x4	16W	20W	24W	28W
2x4	20W	26W	34W	40W

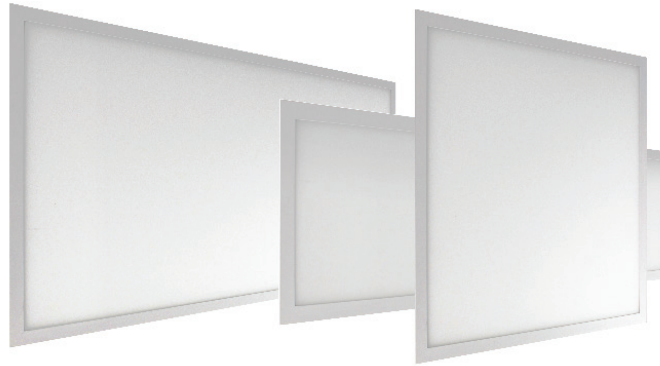

flexCONTROL

hidden integrated high/low motion sensor

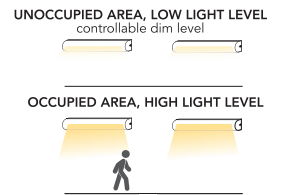

12 FIXTURES IN 1 WITH FLEXWATT™ & FLEXCOLOR™ TECHNOLOGY

- Eliminate ordering and stocking multiple wattages and color temperatures. Product offers 12 SKUs in 1 unit which can easily be configured to 4 different wattage packages and 3 different CCTs.
- Product ships at a default color temp (K) and wattage setting (install as is, or tailor the settings to fit your needs at your facility or on the job site)
- Save on labor costs by having us factory pre-set the wattage and color temperature to fit your project needs.

NEW PMMA LENS – HIGH EFFICIENCY 120-140LPW

- High transmission and high definition (HD) lens.
- Beautiful uniform illumination.
- PMMA material will not yellow over time like other market products.
- LPW varies based on wattage and color selected.

FLICKER-FREE LED DRIVER

FLEXCONTROL™ TECHNOLOGY

- Order control ready or basic control (integrated high/low and daylight sensor) or LG advanced control.
- Vandal Resistant Sensors are completely adjustable and hidden behind the fixture lens.
- Adjustable via remote for sensitivity, duration of time at high light level before dimming to low, duration of time at low light level before dimming to off (factory default is to disable), daylight hold-off, and the dimmed light level.

MANY MOUNTING OPTIONS

- Ships standard with clips for recessed and pendant install.
- Optional low-profile surface mount kit available.

10 YEAR WARRANTY, L70 >100,000HRS

OPTIONAL EMERGENCY BATTERY BACKUP

10 YEAR WARRANTY	UL LISTED	RoHS Compliant	120-277V	0-10V DIM	120-140 LPW	OPERATING TEMP	HT HD PMMA	PWR FACTOR/ THD	CRI 80+	BEAM ANGLE 110°	RATED LIFE	DLC QPL LISTED

RemPhos by Light Efficient Design
lighting on target

FOR PRODUCT INFO ("LED" MODEL #) CONTACT.....Light Efficient Design • 188 S. Northwest Highway • Cary, IL 60013 • 847.380.3540 • led-llc.com
FOR PRODUCT INFO ("RP" MODEL #) CONTACT.....RemPhos by Light Efficient Design • 30 Log Bridge Road, Building 200 • Middleton, MA 01949 • 877.997.3674 • remphos.com

LED PANEL G3 LED FLAT PANEL FIXTURE | FLEXWATT + FLEXCOLOR + FLEXCONTROL



PART NUMBER BUILDER

MFR	FAMILY	PRODUCT	GEN	SIZE	WATTAGE	COLOR	FUNCTION	OPTIONS	BAA	REV
RPT	P	LEDPANEL	G3				FWFC			A

2X2 → 20L,25L,31L,36L 835=3500K/85CRI FWFC= FlexWatt + FlexColor OCC=high/low motion sensor BLANK=NON-BAA
 1X4 → 20L,25L,31L,36L 840=4000K/85CRI EMG=120min emergency battery backup BAA=BAA Section 1605 Compliant
 2X4 → 25L,33L,43L,53L 850=5000K/85CRI LG=LG dongle LGS=LG dongle + sensor

ORDERING EXAMPLE

RPT-P-LEDPANEL-G3-2X2-20L-840-FWFC-A

SURFACE MOUNT ACCESSORIES

RPT-LEDPANEL-SMK-2X2
 RPT-LEDPANEL-SMK-1X4
 RPT-LEDPANEL-SMK-2X4

Default lumen package (wattage and CCT) are shown below in bold. There are two ways to achieve a non-default lumen package and/or CCT:
 1. You can easily adjust in field via our FlexWatt and FlexColor internal switches. 2. Have us adjust the FlexWatt and FlexColor at the factory for an additional charge.

ORDERING GUIDE

CASE QTY	QUICK SHIP	REMPHOS PART #	QUICK SHIP UPC CODE	LUMEN OUTPUT (LM)	WATTAGE (W)	DLC CODE	CCT (K)	WARRANTY (YRS)
4		RPT-P-LEDPANEL-G3-2X2-20L-835-FWFC-A		2000	16	PX48MSP8	3500	10
4	●	RPT-P-LEDPANEL-G3-2X2-20L-840-FWFC-A	844006020965	2032	16	PX48MSP8	4000	10
4	●	RPT-P-LEDPANEL-G3-2X2-20L-840-FWFC-OCC-A	844006020996	2032	16	PX48MSP8	4000	10
4		RPT-P-LEDPANEL-G3-2X2-20L-850-FWFC-A		2032	16	PX48MSP8	5000	10
4		RPT-P-LEDPANEL-G3-2X2-25L-835-FWFC-A		2500	20	P3M9Q2TH	3500	10
4		RPT-P-LEDPANEL-G3-2X2-25L-840-FWFC-A		2540	20	P3M9Q2TH	4000	10
4		RPT-P-LEDPANEL-G3-2X2-25L-850-FWFC-A		2540	20	P3M9Q2TH	5000	10
4		RPT-P-LEDPANEL-G3-2X2-31L-835-FWFC-A		3072	24	PKVKTE8G	3500	10
4		RPT-P-LEDPANEL-G3-2X2-31L-840-FWFC-A		3120	24	PKVKTE8G	4000	10
4		RPT-P-LEDPANEL-G3-2X2-31L-850-FWFC-A		3120	24	PKVKTE8G	5000	10
4		RPT-P-LEDPANEL-G3-2X2-36L-835-FWFC-A		3584	28	PXMWP8SF	3500	10
4		RPT-P-LEDPANEL-G3-2X2-36L-840-FWFC-A		3640	28	PXMWP8SF	4000	10
4		RPT-P-LEDPANEL-G3-2X2-36L-850-FWFC-A		3640	28	PXMWP8SF	5000	10
4		RPT-P-LEDPANEL-G3-1X4-20L-835-FWFC-A		1968	16	P43PG8QH	3500	10
4		RPT-P-LEDPANEL-G3-1X4-20L-840-FWFC-A		1984	16	P43PG8QH	4000	10
4		RPT-P-LEDPANEL-G3-1X4-20L-850-FWFC-A		2000	16	P43PG8QH	5000	10
4		RPT-P-LEDPANEL-G3-1X4-25L-835-FWFC-A		2460	20	P1WW0TYR	3500	10
4	●	RPT-P-LEDPANEL-G3-1X4-25L-840-FWFC-A	844006020972	2480	20	P1WW0TYR	4000	10
4	●	RPT-P-LEDPANEL-G3-1X4-25L-840-FWFC-OCC-A	844006021009	2480	20	P1WW0TYR	4000	10
4		RPT-P-LEDPANEL-G3-1X4-25L-850-FWFC-A		2500	20	P1WW0TYR	5000	10
4		RPT-P-LEDPANEL-G3-1X4-31L-835-FWFC-A		3000	24	PSYAARHG	3500	10
4		RPT-P-LEDPANEL-G3-1X4-31L-840-FWFC-A		3048	24	PSYAARHG	4000	10
4		RPT-P-LEDPANEL-G3-1X4-31L-850-FWFC-A		3100	24	PSYAARHG	5000	10
4		RPT-P-LEDPANEL-G3-1X4-36L-835-FWFC-A		3500	28	P4TU9MKO	3500	10
4		RPT-P-LEDPANEL-G3-1X4-36L-840-FWFC-A		3556	28	P4TU9MKO	4000	10
4		RPT-P-LEDPANEL-G3-1X4-36L-850-FWFC-A		3556	28	P4TU9MKO	5000	10
4		RPT-P-LEDPANEL-G3-2X4-25L-835-FWFC-A		2540	20	PJORV2FM	3500	10
4		RPT-P-LEDPANEL-G3-2X4-25L-840-FWFC-A		2600	20	PJORV2FM	4000	10
4		RPT-P-LEDPANEL-G3-2X4-25L-850-FWFC-A		2600	20	PJORV2FM	5000	10
4		RPT-P-LEDPANEL-G3-2X4-33L-835-FWFC-A		3350	26	P9PLTZK0	3500	10
4	●	RPT-P-LEDPANEL-G3-2X4-33L-840-FWFC-A	844006021535	3390	26	P9PLTZK0	4000	10
4	●	RPT-P-LEDPANEL-G3-2X4-33L-840-FWFC-OCC-A	844006021542	3390	26	P9PLTZK0	4000	10
4		RPT-P-LEDPANEL-G3-2X4-33L-850-FWFC-A		3400	26	P9PLTZK0	5000	10
4		RPT-P-LEDPANEL-G3-2X4-43L-835-FWFC-A		4390	34	POTRQW1A	3500	10
4		RPT-P-LEDPANEL-G3-2X4-43L-840-FWFC-A		4450	34	POTRQW1A	4000	10
4		RPT-P-LEDPANEL-G3-2X4-43L-850-FWFC-A		4450	34	POTRQW1A	5000	10
4		RPT-P-LEDPANEL-G3-2X4-53L-835-FWFC-A		5160	40	PJ6B8J5J	3500	10
4		RPT-P-LEDPANEL-G3-2X4-53L-840-FWFC-A		5300	40	PJ6B8J5J	5000	10
4		RPT-P-LEDPANEL-G3-2X4-53L-850-FWFC-A		5300	40	PJ6B8J5J	5000	10



FOR PRODUCT INFO ("LED" MODEL #) CONTACT.....Light Efficient Design • 188 S. Northwest Highway • Cary, IL 60013 • 847.380.3540 • led-llc.com
 FOR PRODUCT INFO ("RP" MODEL #) CONTACT.....RemPhos by Light Efficient Design • 30 Log Bridge Road, Building 200 • Middleton, MA 01949 • 877.997.3674 • remphos.com

LED PANEL G3 LED FLAT PANEL FIXTURE | FLEXWATT + FLEXCOLOR + FLEXCONTROL



HOW DOES IT WORK?

Our exclusive LED driver is designed to operate at 90%+ efficiency at each wattage setting. Standard drivers would have much lower efficiency as low as 60% and would result in poor performance and reduced efficacy.

WHAT ARE THE WATTAGE CHOICES?

The 2x2, 1x4 & 2x4 fixtures have different wattage/lumen offerings. Please reference this table and the ordering guide on the last page of the cut sheet.

FLEXWATT TURN DIAL POSITION				
SIZE	0	1	2	3
2X2	16W (20L)	20W (25L)	24W (31L)	28W (36L)
1X4	16W (20L)	20W (25L)	24W (31L)	28W (36L)
2X4	20W (25L)	26W (33L)	34W (43L)	40W (53L)

HOW EASY IS IT TO SET?

Simply open the driver cover, adjust the 4-position turn dial with a small, flat-head screw driver, and replace the cover. Quick and easy. Can be "locked-out" to prevent field-adjustability if desired.

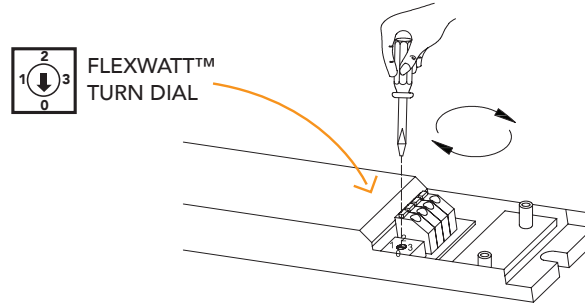

HOW DOES IT WORK?

We select the highest efficacy, multiple color LED diodes from quality suppliers, and mount them on the same circuit board. A proprietary LED binning process ensures color consistency between fixtures. The FlexColor technology controller ensures the correct color is selected, every time.

WHAT ARE THE COLOR CHOICES?

3500k, 4000k and 5000k. Please reference this table and the ordering guide on the last page of the cut sheet.

FLEXCOLOR SLIDE SWITCH POSITION		
TOP	MIDDLE	BOTTOM
3500K	4000K	5000K

HOW EASY IS IT TO SET?

Adjust the 3-position slide switch with your finger. Quick and easy. Can be "locked-out" to prevent field-adjustability if desired.

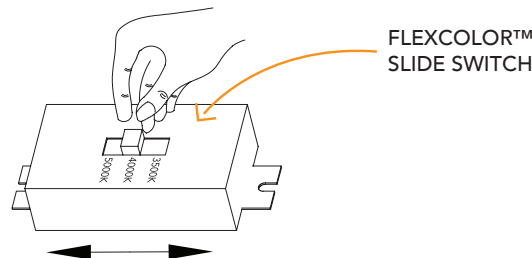

RemPhos by Light Efficient Design
lighting on target

FOR PRODUCT INFO ("LED" MODEL #) CONTACT.....Light Efficient Design • 188 S. Northwest Highway • Cary, IL 60013 • 847.380.3540 • led-llc.com
FOR PRODUCT INFO ("RP" MODEL #) CONTACT.....RemPhos by Light Efficient Design • 30 Log Bridge Road, Building 200 • Middleton, MA 01949 • 877.997.3674 • remphos.com

04.17.19 Information is subject to change without notice.

LED PANEL G3 LED FLAT PANEL FIXTURE | FLEXWATT + FLEXCOLOR + FLEXCONTROL

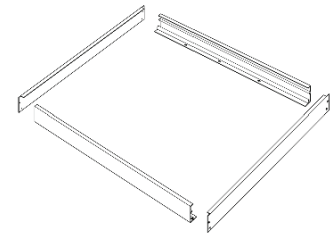
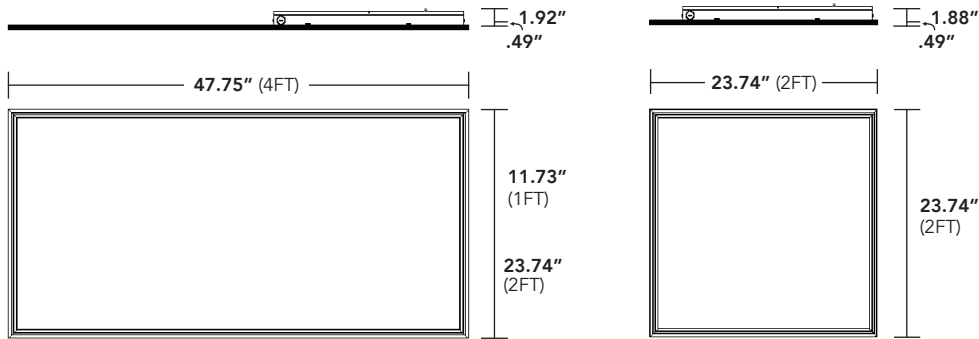

SURFACE MOUNT KIT ACCESSORY (2X2 SHOWN)
HEIGHT/DEPTH OF KIT 2.5"

CONTROL OPTIONS

CONTROL READY

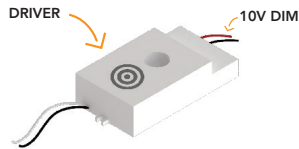

All LEDCR/SR come standard as factory enabled to add controls at the factory, in the field or at a later date. Driver comes with 10V dimming and 12V DC power wiring.

BASIC CONTROL



Integrated high frequency, high/low motion and daylight sensor. Can be mounted behind glass or plastic lens. Default settings: SENSITIVITY: 75%, TIME DIM: 5MIN, TIME OFF = DISABLED, PHOTOCELL: DISABLED, DIM LEVEL: 20%. Purchase optional remote control to adjust settings.

ORDERING CODES

SENSOR = OCC / REMOTE CONTROL = HC REMOTE

LG SENSOR CONNECT



LG's intelligent wireless lighting control system. ZigBee technology. Allows for occupancy sensing, daylight harvesting, grouping, scheduling, high-end trim and more. Adjust settings via Android app. Contact us for more details.

ORDERING CODE = LG or LGS

EASY INSTALL WITH INTEGRATED GRID CLIPS
SIMPLY BEND UP AND OUT. THEN, WHEN LOWERED INTO THE CEILING, THEY CATCH ON T-GRID BAR, FOR ADDED SUPPORT.

- FLEXWATT DRIVER
- SLIDE SWITCH FOR FLEX COLOR (3 CCT OPTIONAL)
- MOTION SENSOR (OPTIONAL)
- BACK COVER WITH ESD PROTECTION
- POSITION FOR EMG ATTACHMENT
- CLIPS FOR T-BAR INSTALLATION
- EVA PROTECTION PLATE
- 100% PMMA MATERIAL LIGHT GUIDE
- LED EFFICACY > 200LM/W L70 > 100,000HRS
- 100% PMMA NON-YELLOWING DIFFUSER
- 12.5MM THICK STRONG ALUMINUM FRAME

RemPhos by Light Efficient Design
lighting on target

FOR PRODUCT INFO ("LED" MODEL #) CONTACT.....Light Efficient Design • 188 S. Northwest Highway • Cary, IL 60013 • 847.380.3540 • led-llc.com
FOR PRODUCT INFO ("RP" MODEL #) CONTACT.....RemPhos by Light Efficient Design • 30 Log Bridge Road, Building 200 • Middleton, MA 01949 • 877.997.3674 • remphos.com

04.17.19 Information is subject to change without notice.